



ASSEMBLY INSTRUCTION

NL2FX / NL2FRX

speakON® SPX Series | Lockable Loudspeaker Connector

IMPORTANT SAFETY INSTRUCTION

Electrical Rating acc. UL & CSA:
USR: 40A/250V, CNR: 25A/250V

“CAUTION: NOT FOR INTERRUPTING CURRENT”
“ATTENTION: NE PAS UTILISER POUR COUPER LE COURANT”

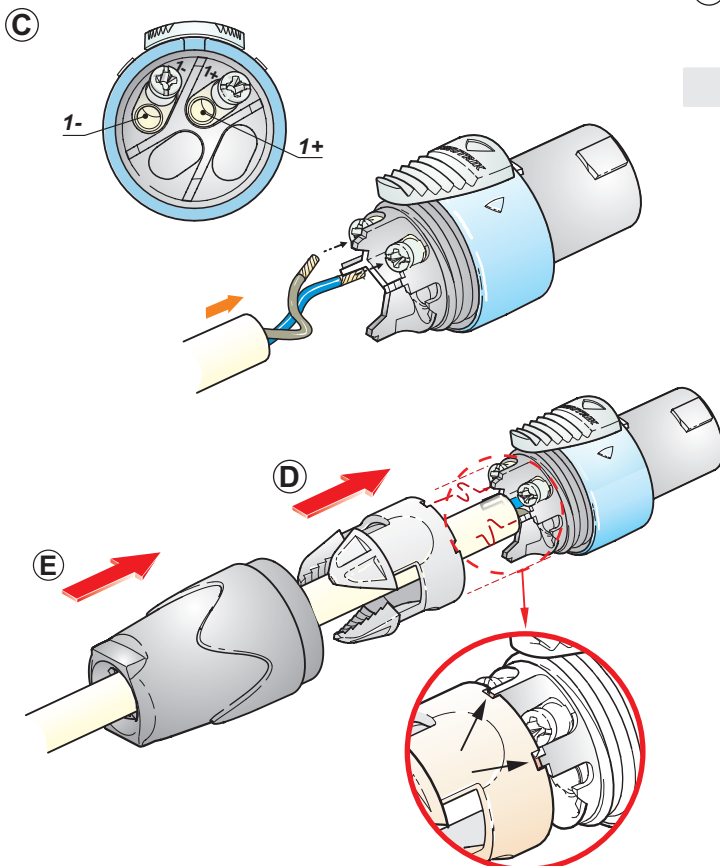
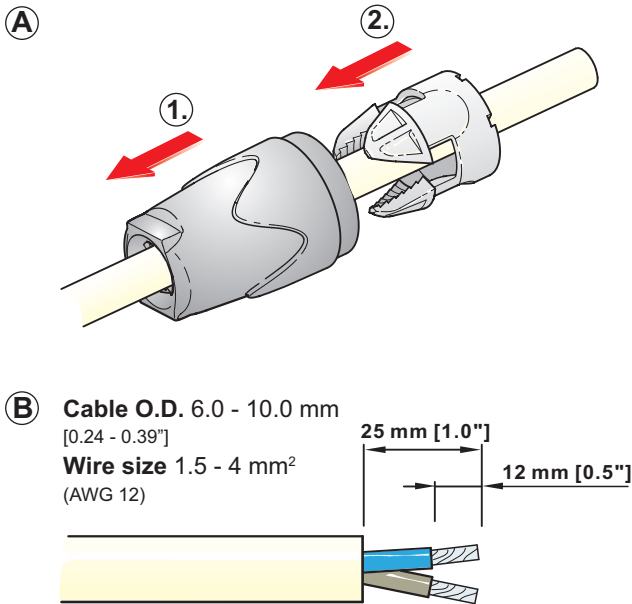

Assembly of the Connector:

A Place bushing and chuck over cable.

B Prepare cable as shown.

Important is the stripping length of 25 mm and 12 mm.

C Insert wires into terminals and secure clamp terminals with screw driver (POZIDRIV® #1) at max. torque 0.8 Nm.

For 6 mm² (AWG 10) remove screws, clamping sheet and solder.

D Push chuck up to housing .

Important: Align the chuck by positioning the nose into the recess.

E Finish installation by turning the bushing onto the connector.

INFO to the screw driver:

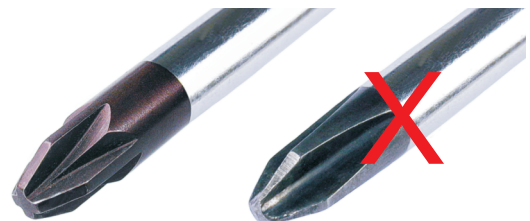

DO NOT USE!

POZIDRIV® #1

Philips

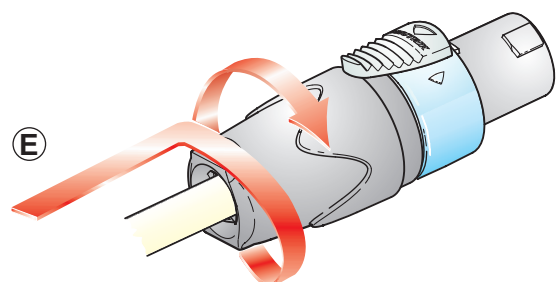



Assembly of the Conversion Kit LRX:

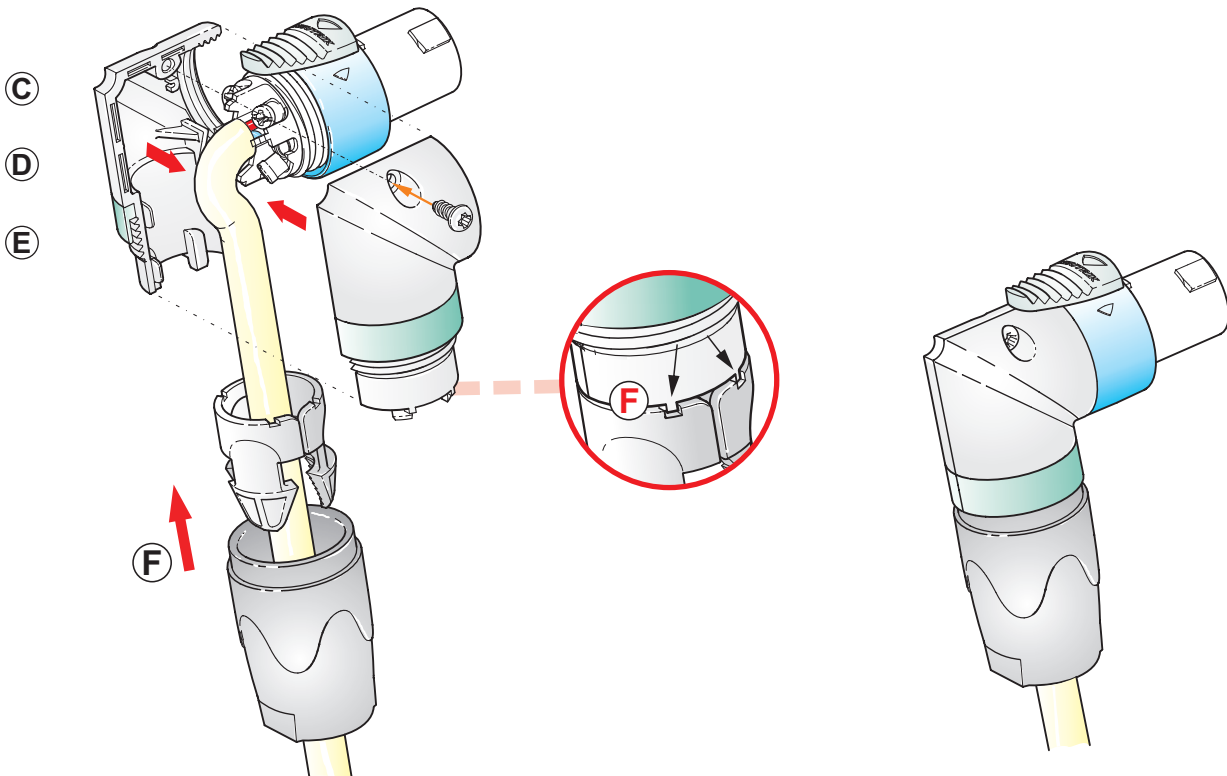
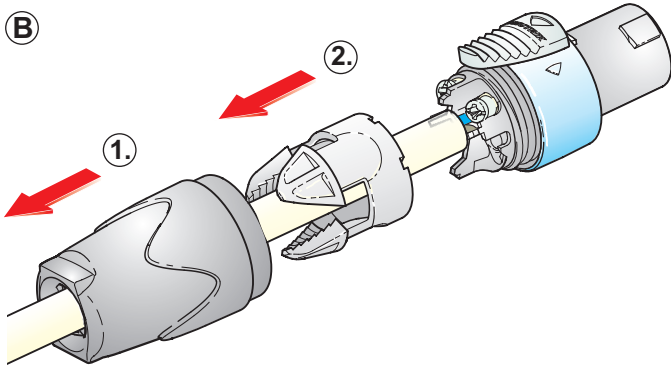
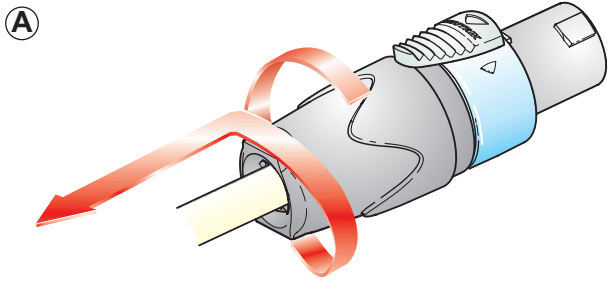

- A** Open the bushing.
- B** Slide the bushing and the chuck back.
- C** Bend the cable as shown.
- D** Position the two conversion shells to fit on the connector thread.
- E** Press together and fix by screw.
- F** Slide the chuck onto the housing and fasten the bushing.

Important: Align the chuck by positioning the nose into the recess.