

## BN 671 - DIN 125 A - ~ISO 7089

Flat washers  
without chamfer

DIN 125 A  
~ISO 7089  
VSM 13904  
~UNI 6592

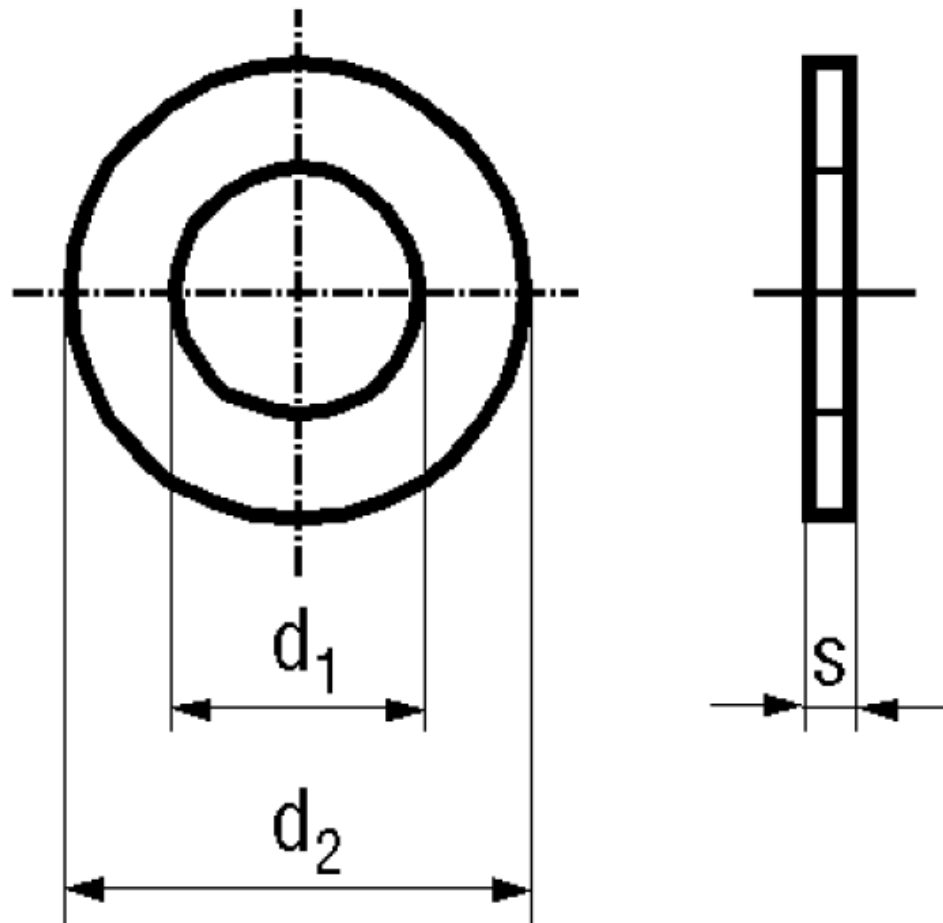

Material	Stainless steel	Hardness grade	140 HV
Quality	A4		

### Article No. - 1253360

fit for	M3
$d_1$	3,2
$d_2$	7
$s$	0,5

DIN 125: Standard withdrawn